

General Description

SFGMOS[®] MOSFET is based on Oriental Semiconductor's unique device design to achieve low $R_{DS(ON)}$, low gate charge, fast switching and excellent avalanche characteristics. The low V_{th} series is specially designed to use in synchronous rectification power systems with low driving voltage.

Features

- Low $R_{DS(ON)}$ & FOM
- Extremely low switching loss
- Excellent reliability and uniformity
- Fast switching and soft recovery



Applications

- PD charger
- Motor driver
- Switching voltage regulator
- DC-DC convertor
- Switched mode power supply

Key Performance Parameters

Parameter	Value	Unit
$V_{DS, min} @ T_{j(max)}$	100	V
$I_{D, pulse}$	180	A
$R_{DS(ON) max} @ V_{GS}=10V$	12	m Ω
Q_g	49.9	nC

Marking Information

Product Name	Package	Marking
SFG10R12DF	TO252	SFG10R12D

Package & Pin information

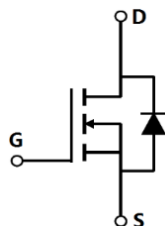

Absolute Maximum Ratings at $T_j=25^{\circ}\text{C}$ unless otherwise noted

Parameter	Symbol	Value	Unit
Drain source voltage	V_{DS}	100	V
Gate source voltage	V_{GS}	± 20	V
Continuous drain current ¹⁾ , $T_C=25^{\circ}\text{C}$	I_D	60	A
Pulsed drain current ²⁾ , $T_C=25^{\circ}\text{C}$	$I_{D, pulse}$	180	A
Continuous diode forward current ¹⁾ , $T_C=25^{\circ}\text{C}$	I_S	60	A
Diode pulsed current ²⁾ , $T_C=25^{\circ}\text{C}$	$I_{S, Pulse}$	180	A
Power dissipation ³⁾ , $T_C=25^{\circ}\text{C}$	P_D	125	W
Single pulsed avalanche energy ⁵⁾	E_{AS}	100	mJ
Operation and storage temperature	T_{stg}, T_j	-55 to 150	$^{\circ}\text{C}$

Thermal Characteristics

Parameter	Symbol	Value	Unit
Thermal resistance, junction-case	$R_{\theta JC}$	1	$^{\circ}\text{C/W}$
Thermal resistance, junction-ambient ⁴⁾	$R_{\theta JA}$	62	$^{\circ}\text{C/W}$

Electrical Characteristics at $T_j=25^{\circ}\text{C}$ unless otherwise specified

Parameter	Symbol	Min.	Typ.	Max.	Unit	Test condition
Drain-source breakdown voltage	BV_{DSS}	100			V	$V_{GS}=0\text{ V}, I_D=250\ \mu\text{A}$
Gate threshold voltage	$V_{GS(th)}$	1.0		2.5	V	$V_{DS}=V_{GS}, I_D=250\ \mu\text{A}$
Drain-source on-state resistance	$R_{DS(ON)}$		10	12	$\text{m}\Omega$	$V_{GS}=10\text{ V}, I_D=10\text{ A}$
Drain-source on-state resistance	$R_{DS(ON)}$		12	14	$\text{m}\Omega$	$V_{GS}=4.5\text{ V}, I_D=10\text{ A}$
Gate-source leakage current	I_{GSS}			100	nA	$V_{GS}=20\text{ V}$
				-100		$V_{GS}=-20\text{ V}$
Drain-source leakage current	I_{DSS}			1	μA	$V_{DS}=100\text{ V}, V_{GS}=0\text{ V}$

Dynamic Characteristics

Parameter	Symbol	Min.	Typ.	Max.	Unit	Test condition
Input capacitance	C_{iss}		3150		pF	$V_{GS}=0\text{ V}$, $V_{DS}=50\text{ V}$, $f=100\text{ kHz}$
Output capacitance	C_{oss}		359.3		pF	
Reverse transfer capacitance	C_{rss}		7.3		pF	
Turn-on delay time	$t_{d(on)}$		20.6		ns	$V_{GS}=10\text{ V}$, $V_{DS}=50\text{ V}$, $R_G=2.2\ \Omega$, $I_D=25\text{ A}$
Rise time	t_r		5		ns	
Turn-off delay time	$t_{d(off)}$		51.8		ns	
Fall time	t_f		9		ns	

Gate Charge Characteristics

Parameter	Symbol	Min.	Typ.	Max.	Unit	Test condition
Total gate charge	Q_g		49.9		nC	$V_{GS}=10\text{ V}$, $V_{DS}=50\text{ V}$, $I_D=25\text{ A}$
Gate-source charge	Q_{gs}		6.5		nC	
Gate-drain charge	Q_{gd}		12.4		nC	
Gate plateau voltage	$V_{plateau}$		3.4		V	

Body Diode Characteristics

Parameter	Symbol	Min.	Typ.	Max.	Unit	Test condition
Diode forward voltage	V_{SD}			1.3	V	$I_S=12\text{ A}$, $V_{GS}=0\text{ V}$
Reverse recovery time	t_{rr}		60.4		ns	$V_R=50\text{ V}$, $I_S=12\text{ A}$, $di/dt=100\text{ A}/\mu\text{s}$
Reverse recovery charge	Q_{rr}		106.1		nC	
Peak reverse recovery current	I_{rrm}		3		A	

Note

- 1) Calculated continuous current based on maximum allowable junction temperature.
- 2) Repetitive rating; pulse width limited by max. junction temperature.
- 3) P_d is based on max. junction temperature, using junction-case thermal resistance.
- 4) The value of $R_{\theta JA}$ is measured with the device mounted on 1 in 2 FR-4 board with 2oz. Copper, in a still air environment with $T_a=25\text{ }^\circ\text{C}$.
- 5) $V_{DD}=50\text{ V}$, $V_{GS}=10\text{ V}$, $L=0.3\text{ mH}$, starting $T_j=25\text{ }^\circ\text{C}$.

Electrical Characteristics Diagrams

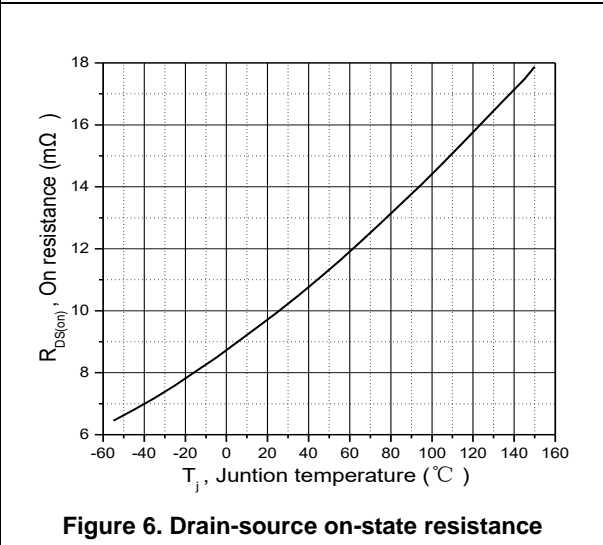
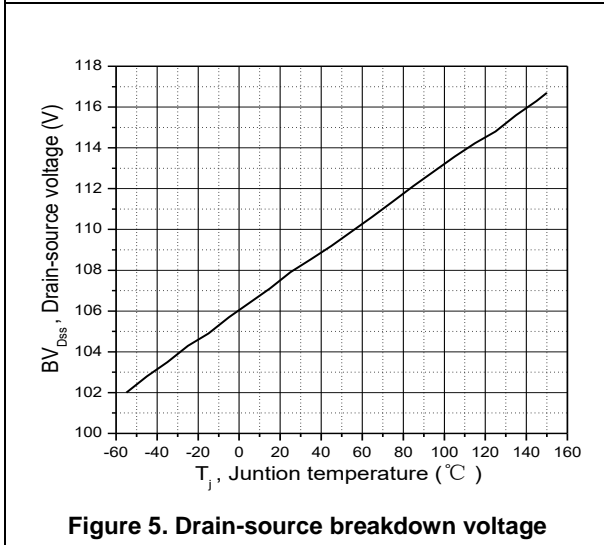
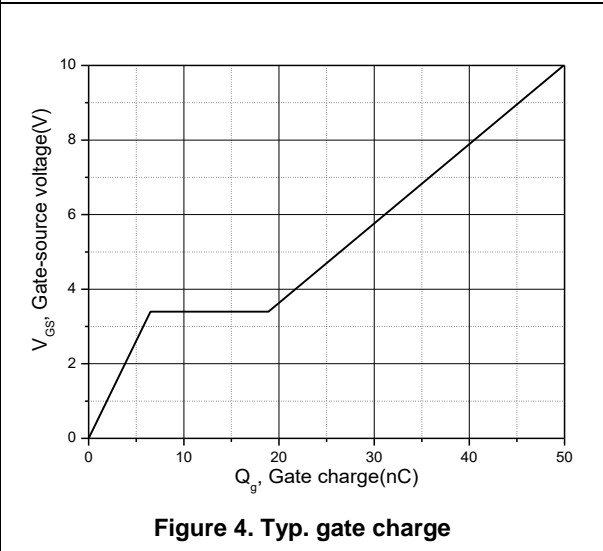
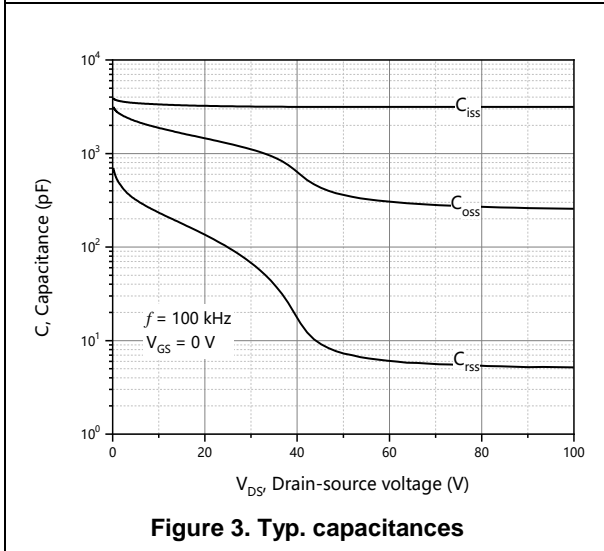
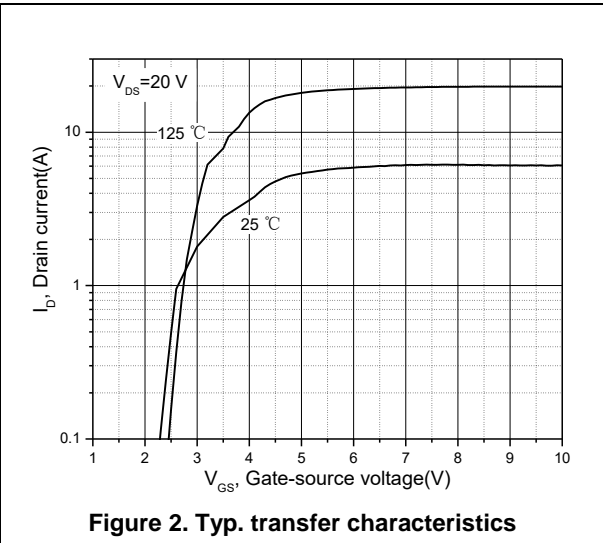
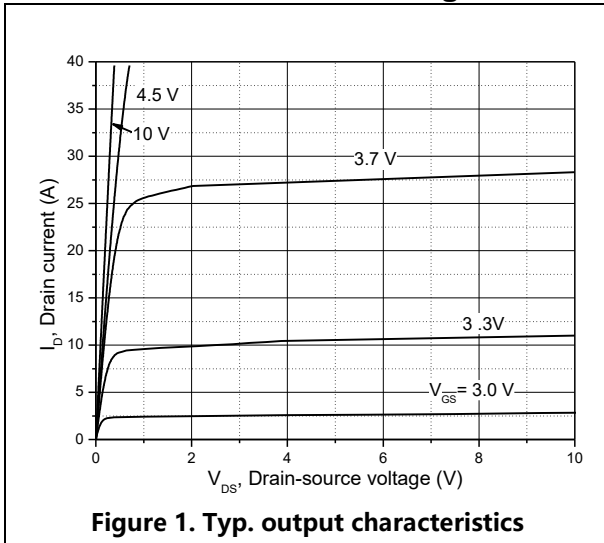

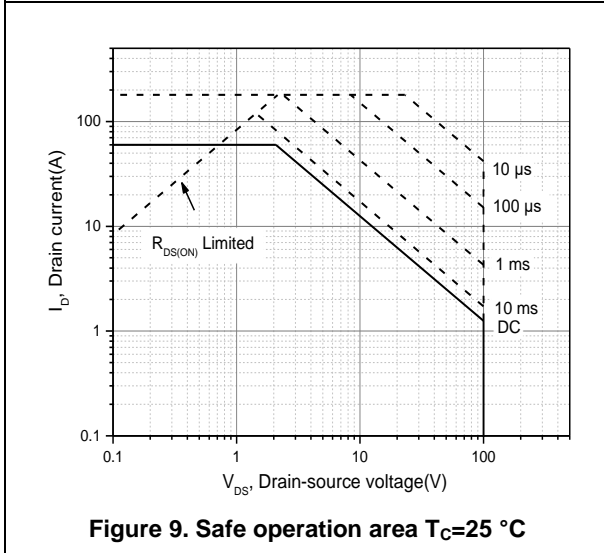
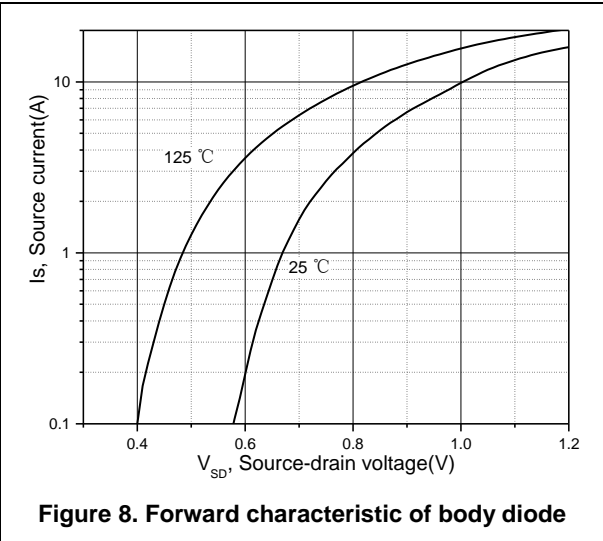
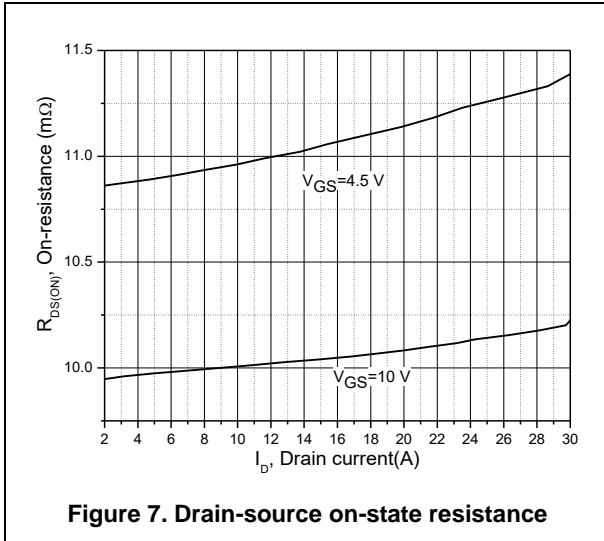

Test circuits and waveforms

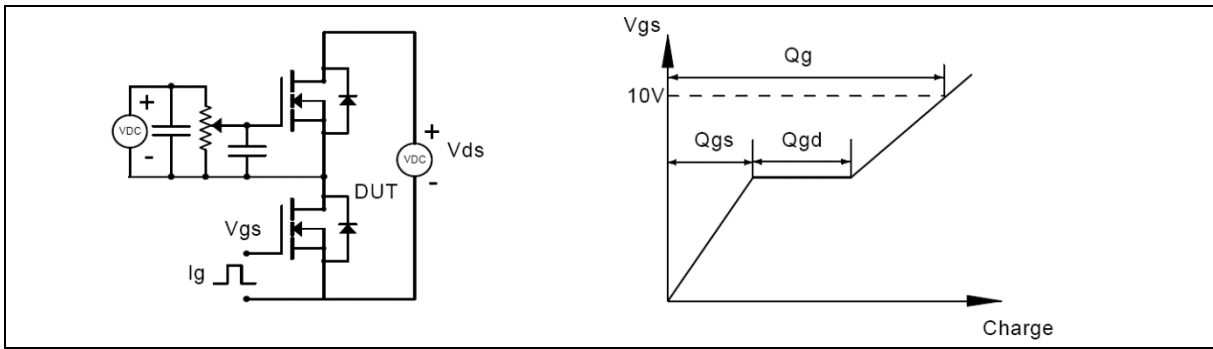

Figure 1. Gate charge test circuit & waveform

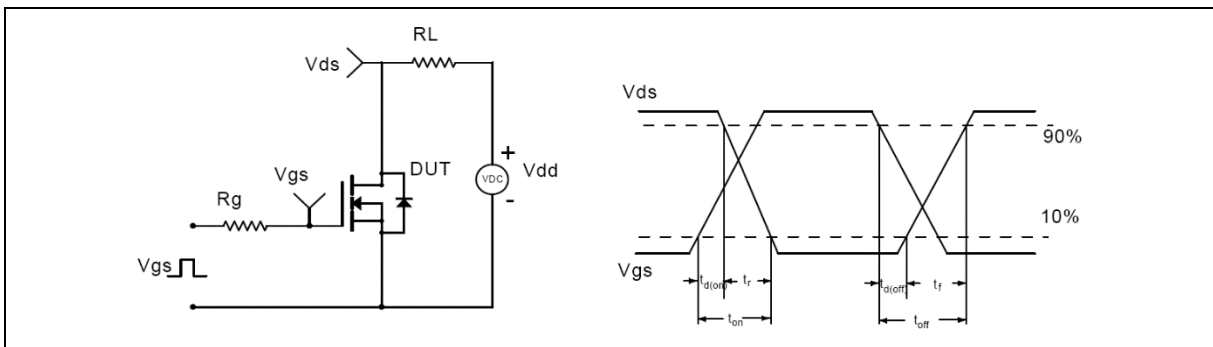

Figure 2. Switching time test circuit & waveforms

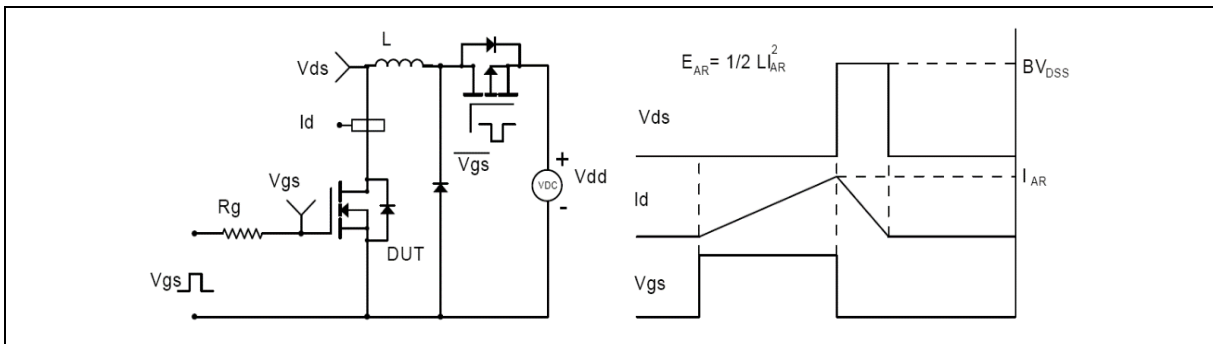

Figure 3. Unclamped inductive switching (UIS) test circuit & waveforms

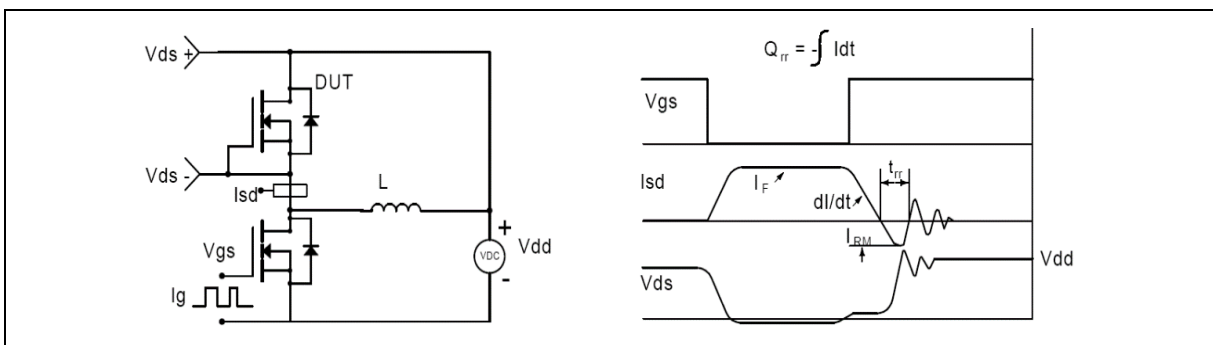
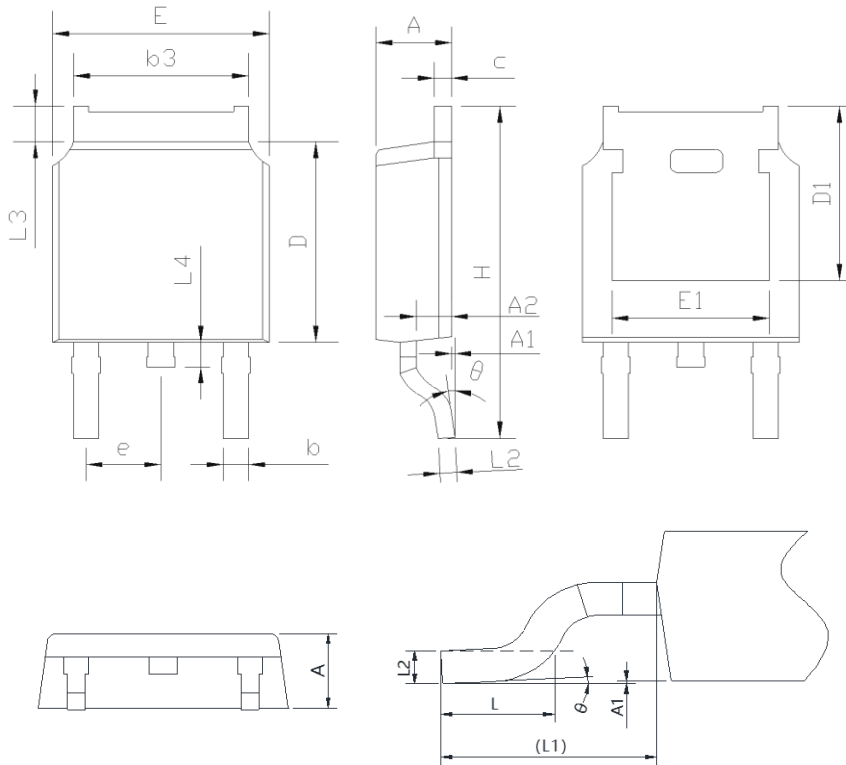

Figure 4. Diode reverse recovery test circuit & waveforms

Package Information



Symbol	mm		
	Min	Nom	Max
A	2.20	2.30	2.38
A1	0.00	-	0.20
A2	0.97	1.07	1.17
b	0.68	0.78	0.90
b3	5.20	5.33	5.46
c	0.43	0.53	0.61
D	5.98	6.10	6.22
D1	5.30 REF		
E	6.40	6.60	6.73
E1	4.63	-	-
e	2.286 BSC		
H	9.40	10.10	10.50
L	1.38	1.50	1.75
L1	2.90 REF		
L2	0.51 BSC		
L3	0.88	-	1.28
L4	0.50	-	1.00
θ	0°	-	8°

Version 1: TO252-C package outline dimension

Ordering Information

Package Type	Units/ Reel	Reels / Inner Box	Units/ Inner Box	Inner Boxes/ Carton Box	Units/ Carton Box
TO252-C	2500	2	5000	5	25000

Product Information

Product	Package	Pb Free	RoHS	Halogen Free
SFG10R12DF	TO252	yes	yes	yes

Legal Disclaimer

The information given in this document shall in no event be regarded as a guarantee of conditions or characteristics. With respect to any examples or hints given herein, any typical values stated herein and/or any information regarding the application of the device, Oriental Semiconductor hereby disclaims any and all warranties and liabilities of any kind, including without limitation, warranties of non-infringement of intellectual property rights of any third party.

For further information on technology, delivery terms and conditions and prices, please contact the Oriental Semiconductor sales representatives (www.orientalsemi.com).

© Oriental Semiconductor Co.,Ltd. All Rights Reserved 